

FICHE TECHNIQUE : **STRIP HOLDER** pour ASECNA

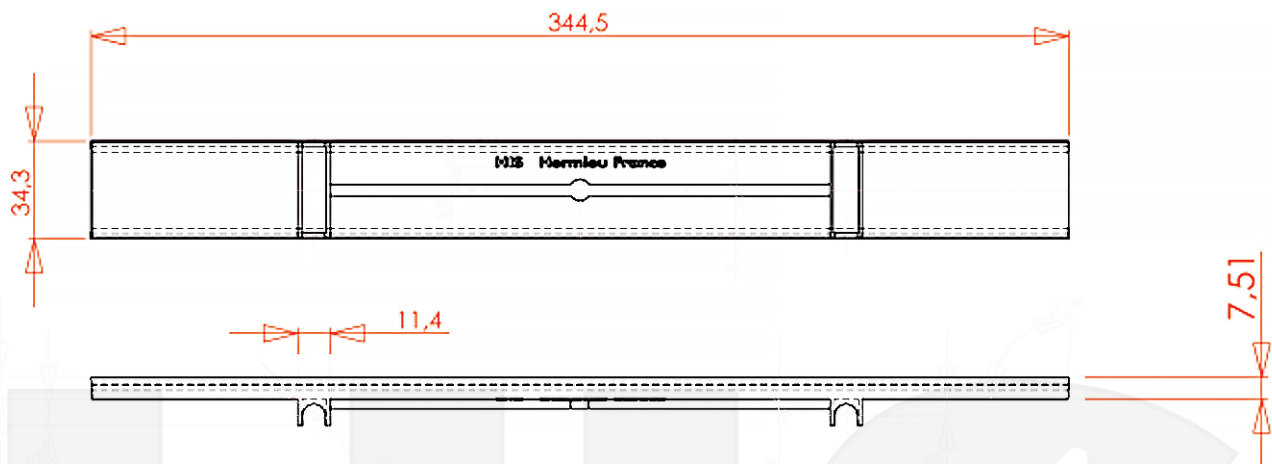

DIMENSION:

Taille 1 : 13"1/2 ou 344.5 mm x 34.3mm

Taille 2 : 10" ou 255mm x 34.3mm

MATÉRIEL OUTIL:

Injection direct central









Empreinte de pied en acier :

1.2311 (30-34 HRC) et 1.2344 (48-52 HRC)

Injection Strip-holder

ABS Terluran GP22 Naturelle (BASF)

COULEURS :

 Bleu	 Rose
 Jaune	 Rouge
 Vert	 Chamois
 Kaki	 Marron
 Blanc	 Noir

OU TOUTES AUTRES
COULEURS SUR DEMANDE

